

INSTALLATION INSTRUCTIONS

READ IMPORTANT SAFETY TIPS BEFORE PROCEEDING WITH INSTALLATION

SAFETY TIPS

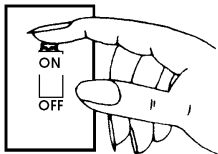

Turn fixture off! (Place wall switch in off position, if fixture has built-in switch or chain pull, switch or pull chain so fixture is off.)



Next - go to the main fuse box. If your fuse box has an ON/OFF switch, simply place main power switch in OFF position

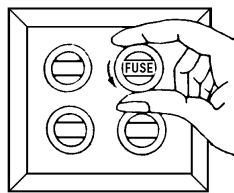

Screw-in type fuses - unscrew the fuse or fuses that control the power to the fixture or room you are working in.

1

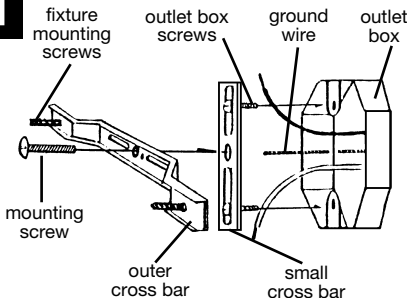

ATTACH small cross bar to outlet box with outlet box screws (8-32 x 1/2, screws not provided).
THREAD fixture mounting screws (8-32 x 1,2 provided) into large cross bar.
ATTACH large cross bar to small cross bar with mounting screw (1/4 - 20 x 3/8,1 provided).

2

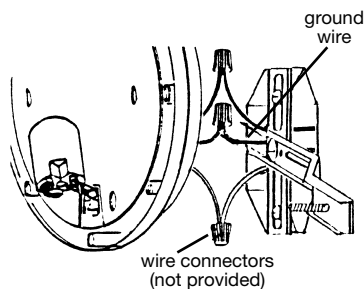

CONNECT THE WIRES. NOTE: Attach black fixture wire to black supply wire, white fixture wire to white supply wire. Do not mix them up. Use approved electrical tape or wire connectors (not provided). Connect bare fixture ground wire to ground wire from outlet box. NEVER CONNECT GROUND WIRE TO BLACK OR WHITE POWER SUPPLY WIRES.

3

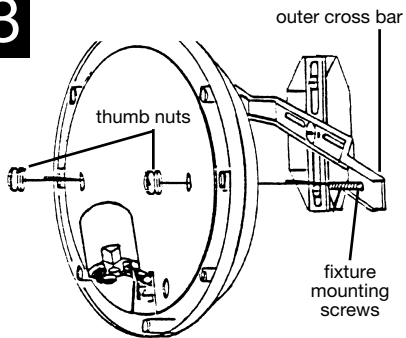

POSITION THE FIXTURE over the large cross bar and secure in place with the thumb nuts (2 provided). Screw bulb into socket. Be sure to use bulb with wattage no greater than specified for this fixture.

4

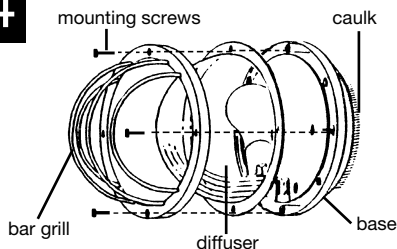

PLACE DIFFUSER ON FIXTURE BASE. Then place bar grill on frame over diffuser and attach to base with mounting screws (8-32 x 1/2, 4 combination head screws provided). NOTE: Outdoor wall fixture MUST be caulked with an acrylic caulk where base of fixture meets mounting surface. This provides a water tight seal when fixture is installed.

NOTE: BE SURE WIRES EXITING BACK OF FIXTURE ARE NOT PINCHED BETWEEN THE BACK OF FIXTURE AND CEILING OR WALL

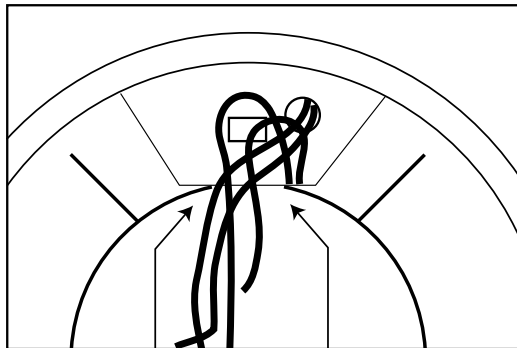

CORRECT

WIRES **MUST** LAY IN THIS SLOT

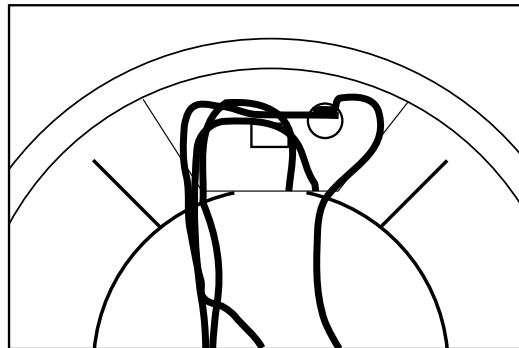

INCORRECT